

Dimensions: mm

General Tolerance: DIN 40680

Brown Color Galze: RAL 8016

Grinding Surface ∇

Visual Inspection: IEC 62155 10.3

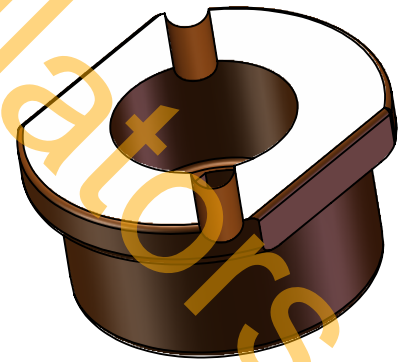
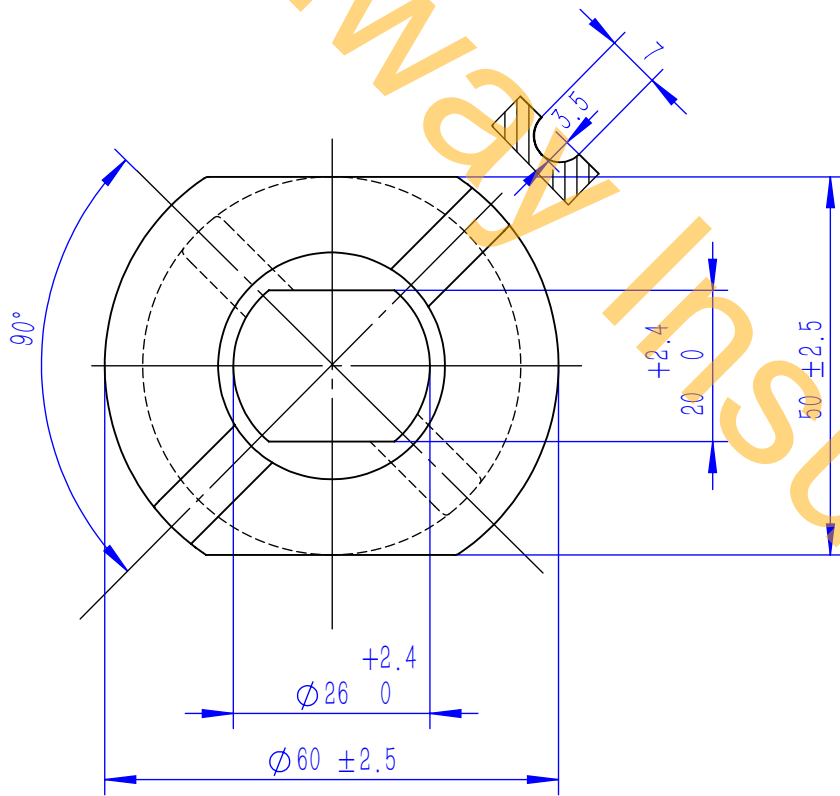

			Kaiway Electric Industrial Mfg Co., Ltd	
标记	更改文件号	年月日	DIN 42530 1KV250 Bottom	
设计	标准化			
校核	工艺			
主管设计	审核			
批准				